



ATENA S.P.A. HAS A QUALITY
MANAGEMENT SYSTEM
CERTIFICATED BY RINA
IN COMPLIANCE WITH ISO 9001



Metal Modular

Flat 24

PANELS DIMENSIONS

600x600 mm

TYPE

Aligned Lay-in panels

Right edge | shaped edges

PANELS MATERIALS AND WEIGHT

Aluminum 5/10: 1,50 kg/sqm Steel 5/10: 4,28 kg/sqm

Aluminum 6/10: 1,80 kg/sqm Steel 6/10: 5,13 kg/sqm

Aluminum 7/10: 2,10 kg/sqm

STRUCTURE WEIGHT

Steel Strong Easy T24 | Easy Antiseismic T24: 0,97 kg/sqm

Steel Strong Easy Fox T24: 0,86 kg/sqm

Hangers not included

T24 VISIBLE STRUCTURE

Steel Strong Easy | Easy Antiseismic | Easy Fox

ANTI-SEISMIC EQUIPMENTS

Atena Antiseismic Kit for $\leq 1,2$ m plenum

Atena Antiseismic Kit for $> 1,2$ m high plenum

HANGERS

Twister, Nonius, Standard with spring, 90° hanger

Suspensions to evaluate according to the load at m^2 , to the project features and antiseismic requirements.

COLORS

Atena white, Atena silver pre-painted aluminum

Atena white, Atena silver pre-painted steel

RAL / NCS coatings

FINISHING

Plain or perforated surface

Sublimation of images and effects | Digital printing

PERFORATION

To choose among Atena perforation range

WALL ANGLES

"L" 20x20 | 20x25 | 25x25 | 30x30 mm

Doppia "L" 25x8x15x15 mm

"C" 18x42x25 mm

"F" 13, F "15"

ACCESSORIES

Air-flow panels on request



SECTIONS

Metal ceiling made up of laid on T24 visible structure lowered panels.

Right edge



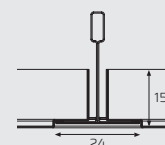
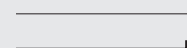



Aligned



TECHNICAL PERFORMANCES

	FLEXION RESISTANCE	Maximum span mm 1200 - 1 Class EN13964
	CORROSION RESISTANCE	Galvanized steel products: C2 Class Pre-painted galvanized steel products: C3 Class Post-painted galvanized steel products: C4 Class Pre/post-painted aluminum products: C5 Class
	(RH%) RELATIVE HUMIDITY RESISTANCE	Galvanized steel products: ≤ 90% Pre/post-painted galvanized steel products: > 90% Stainless steel and aluminium products: > 90%
	FIRE REACTION UNI EN 13501-1	Structure, suspensions and wall angles: A1 Class Smooth or perforated panels with Plus acoustic fleece: A1 Class Perforated panels with Standard acoustic fleece: A2s1d0 Class
	ACOUSTICS	Information in "Acoustic Performance"
	METAL CEILING MAXIMUM LOAD	Easy T24 and Easy Antiseismic structures 600x600 model: 12 kg/m ² Easy Fox T24 structure 600x600 model: 10 kg/m ²
	LIGHT REFLECTION	Smooth glossy white: up to 85% ISO 7724-2 (3)
	CLEANING	Wet cloth with warm water and neutral non-abrasive detergents.
	COLOR STABILITY	In compliance with technical tolerances standard. Test according the ΔE - CIELab method. ISO 7724-2 (3)
	PAINTED ITEMS DURABILITY	C Class EN13964
	GALVANIZED ITEM DURABILITY	B Class EN13964

SUSTAINABILITY

	RELEASE OF DANGEROUS SUBSTANCES*	None CAM 2.4.13 EN13964		FORMALDEHYDE*	E1 Class CAM 2.3.5.5
	DISASSEMBLY*	Steel Aluminium 100% recyclable CAM 2.4.11		MATERIAL DEMOLITION AND REMOVAL*	Non hazardous waste in compliance with CAM 2.5.1.
	RECYCLED PRODUCT CONTENT*	CAM 2.4.18 compliance		GREEN BUILDING	Requirements: LEED (BREEAM and ITACA for cross-section aspects)

* Data declaration as required by the ISO 14021 standard

BASE 24 STRUCTURE SYSTEM

3700 mm 1200 mm | 600 mm

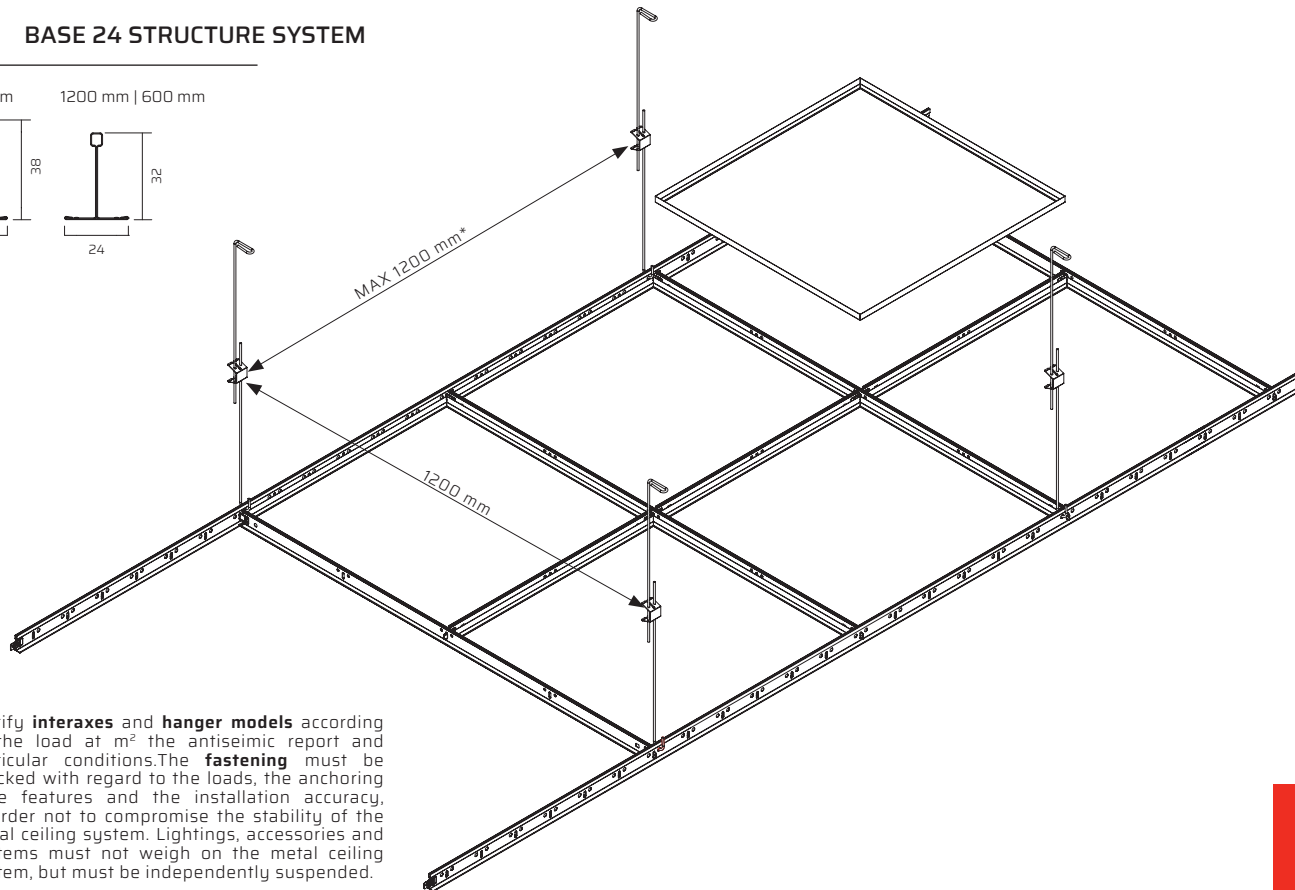
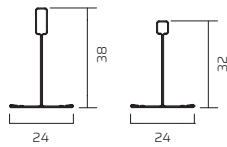

*verify **interaxes** and **hanger models** according to the load at m² the antiseismic report and particular conditions. The **fastening** must be checked with regard to the loads, the anchoring base features and the installation accuracy, in order not to compromise the stability of the metal ceiling system. Lightings, accessories and systems must not weigh on the metal ceiling system, but must be independently suspended.

COMPONENT INCIDENCES

ID	DESCRIPTION	INCIDENCE*
1	FLAT 24 PANEL	2,78 pcs/sqm
2	WALL ANGLE	1 pcs/sqm
3	HANGERS	1 pcs/sqm
4	EASY T24 3700 (h38)	0,85 lm/sqm
5	EASY T24 1200 (h32 h38)	1,70 lm/sqm
6	EASY T24 600 (h32 h38)	0,85 lm/sqm
7	EASY FOX T24 3700 (h38)	0,85 lm/sqm
8	EASY FOX T24 1200 (h32)	1,70 lm/sqm
9	EASY FOX T24 600 (h27 h32)	0,85 lm/sqm

* Component incidences 600x600mm model

HANGERS

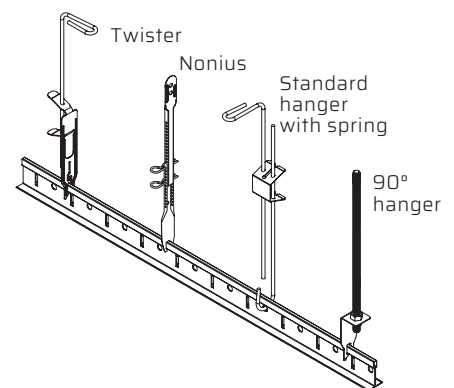

ANTISEISMIC EQUIPPMENTS

According to the NTC 2018, when the non-structural element is assembled on site: structure designer is in charge of identifying the request, the supplier and / or installer is in charge of providing elements and connection systems of adequate capacity, the project manager is in charge of verifying the accuracy of installation". Therefore it is necessary to communicate to Atena the stresses acting on the false ceiling (seismic acceleration, wind load...) in order to allow a proper calculation of the single elements. For more information on Atena's anti-seismic systems, contact the reference sales offices. The documentation on the site is for example only. (NTC 2018 § 7.2.3-7.2.4).

WALL ANGLES

"C" PROFILE

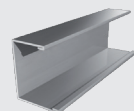

18x42x25 mm
L=4000 mm

"L" PROFILES

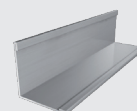

30x30 | 25x25
20x25 | 20x20
L=3050 mm

DOUBLE "L" PROF.

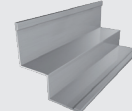

25x8x15x15
L=3050 mm

"F" PROFILES

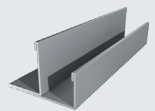

F 13 L=3000 mm
F 15 L=3000 mm

INSTALLATION STEPS

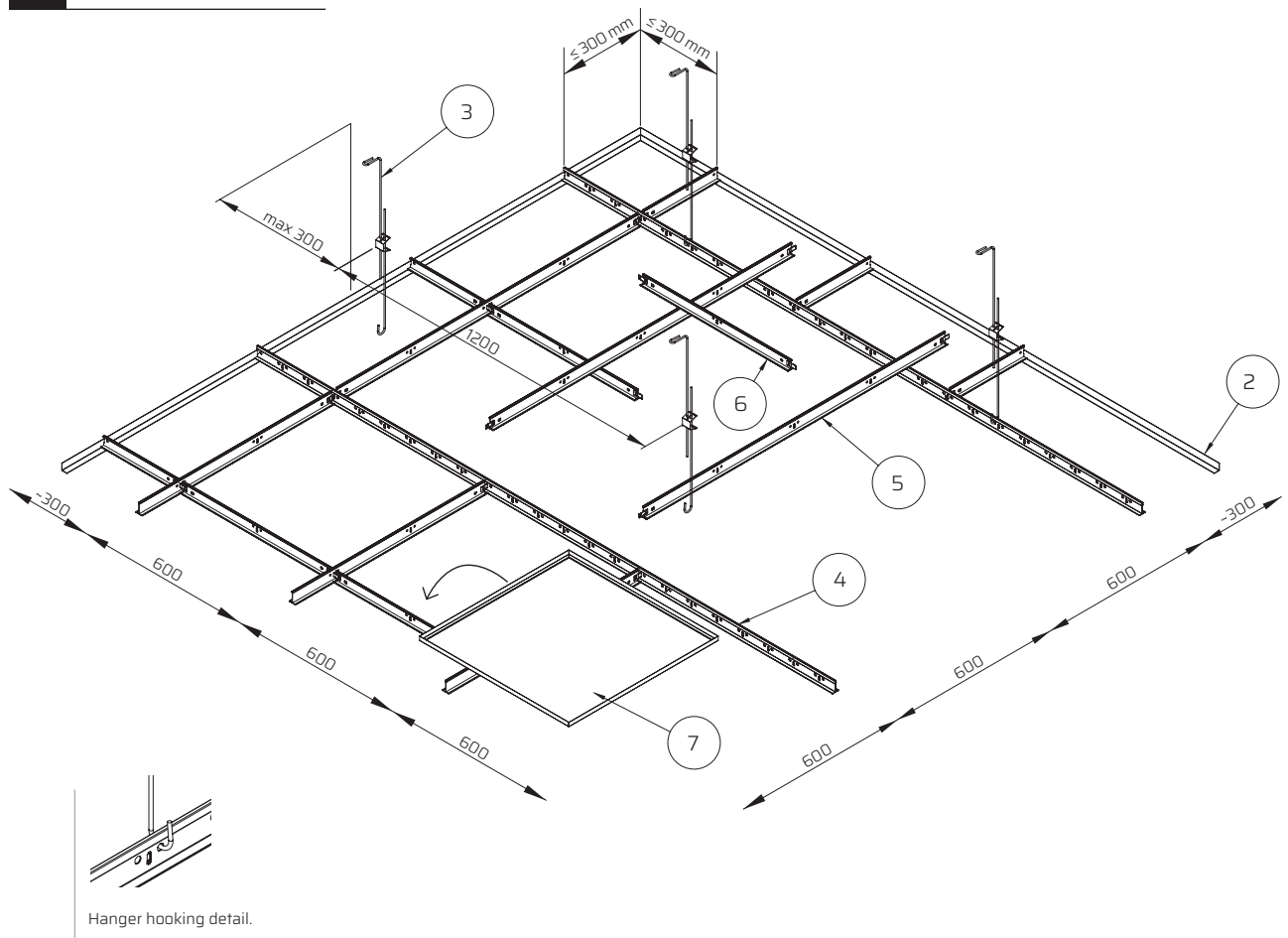

- 1 Draw the lines of the perimeter frame. Determine the height of the ceiling with a level and mark it with a string. Proceed with the structure installation.
- 2 Install the wall angles with nails, screws and / or plugs suitable to the wall material.
- 3 Fix the hangers according to the type of ceiling to be installed.
- 4 Install the main runners with an interaxe of 1200 mm.
- 5 Proceed with the installation of 1200 mm cross T profiles in to the main carrier.
- 6 Install 600 mm Cross T in to 1200 mm Cross T profiles.
- 7 Lay panels on T structure.

The hangers will be hooked to the 3700 mm main profiles with an interaxe of 1200 mm and 900 mm.

*verify **interaxes** and **hanger models** according to the load at m^2 the antiseismic report and particular conditions. The **fastening** must be checked with regard to the loads, the anchoring base features and the installation accuracy, in order not to compromise the stability of the metal ceiling system. Lightings, accessories and systems must not weigh on the metal ceiling system, but must be independently suspended.

To set up a proper coupling of the structure, hold the left side of the punched profile and press slightly to snap the clip into place. The click ensures the proper attachment of the structure. To release, press the tab of the locking clip and remove the profile.

CLEANING, MAINTENANCE AND REMOVAL INSTRUCTIONS

Cleaning and maintenance require some attention and care even though are easy to make and don't take much time. It is necessary to use warm water and neutral and non-abrasive detergents. Metal ceilings maintenance usually refers to: placement, alignment or replacement of damaged or broken modules (panels, staves, baffles, open cells) which can be also removed for restoration or maintenance of the system below.

In order to ensure an excellent results, the maintenance work must be carried out by specialised workers trained with technical data sheets about setting, removal and maintenance of the metal ceilings. Using inadequate tools can damage the bearing structure, causing adherence loss or even accidental modules fall. All the maintenance intervention must follow the technical data sheet instructions or specific information when provided and every diversity has to be promptly reported. Each worker charged with maintenance operation must carefully remove the modules, perform the intervention and do not alter the metal ceiling structure, the hanging system and the connection between these elements.

When the maintenance is over, modules must be installed again, checking that these are well hooked or positioned if they are lay-in/on a visible structure and that the flatness of the assembly is guaranteed. Any difference in level is caused by wrong installation and, for this reason, the system must be quickly controlled.

STORAGE MODE

Materials supplied by Atena S.p.A. shall be maintained in good condition from purchase to installation. Materials must be stored in a closed, clean and dry site, not under direct light. Atena S.p.A. protects its products with resistant packaging under normal handling. Please handle packages with care to avoid shocks and inappropriate handling that might damage what is provided. The manual handling must be carried out with caution and in compliance with safety regulations at work. For carriage of packaged products on pallets, provide a mechanical transport to avoid damages or risks resulting from inadequate transport.

SUSTANABILITY AND SAFETY

All Atena metal ceilings are made with products that do not release dangerous substances into the environment including formaldehyde. Coating and / or sublimation are free from Volatile Organic Compounds (VOC). The products will be recyclable and as a whole manufactured using recycling processes materials, the recycled material percentage is calculated for each type of product, in compliance with CAM requirements and declared according to the ISO 14021 standard. The metal ceiling systems contribute to getting credits for the certification of building design, construction and sustainable and efficient management according to the LEED protocol and to the BREEAM and ITACA cross-cutting aspects.

FASTENERS

Atena supplies the hangers and accessories such as screws, washers and nuts to connect the elements of its own supply only. Lightings, accessories and systems must not weigh on the metal ceiling system, but must be independently suspended. The fastening must be checked with regard to the loads, the anchoring base features and the installation accuracy, in order not to compromise the stability of the metal ceiling system.

NORMATIVE REQUIREMENTS

Atena S.p.A. has adopted a quality management system in compliance with the UNI EN ISO 9001 standard.

All Atena metal ceilings are produced for indoor applications, in compliance with Technical Standards for Construction NTC 2018 and relative circular requirements, the Minimum Environmental Criteria CAM (Ministerial Decree 11 October 2017), the specific technical standards applicable UNI EN 13964 and 14195. Each Atena S.p.A. product has its own DOP (CE Declaration of Performance) according to the European Law for construction products 305/2011.

The performance properties declared in D.o.P. Declarations of Performance provided by Atena S.p.A. are guarantees, if the metal ceiling is installed in the environment conditions for which it has been conceived and the recommended maintenance is executed.

Precisely, metal ceilings are non-structural construction elements therefore they must be properly sized in order to withstand with adequate safety against all actions that can stress the building, such as, but not limited to, earthquakes, winds, thermal expansion, humidity, etc., in relation to the installation site, the building use and the project technical features. Check with Atena technical department the specific environmental conditions to which the product will be subjected, in order to choose the most suitable materials for the installation site.

In the case of outdoor installation, the metal ceilings are not covered by an harmonized technical standard, therefore they are not subject to the regulation 305/2011. They are in any case subjected to the NTC 2018 and to the safety checks of civil constructions, and must be properly sized according to the installation site environmental conditions, to the structural features and to the project specifications.

Independently by information, suggestions, advices and technical opinions exchanged between the parts, during pre-agreement negotiations Atena S.p.A. will manufacture the products only according to the orders received and the technical drawings/projects attached, having no responsibility on what is not indicated in the order, in the technical drawings or in the project.

All rights are reserved and subject to industrial protection. Changes to the illustrated products, even if partial, can be carried out only if explicitly authorized by the company Atena S.p.A. All data provided and illustrated are indicative and Atena S.p.A. reserves the right to make changes at any time according the business needs and the production processes.

The information contained in this following sheet must to be considered updated at the date of writing. Changes in product performance occurred after that date may affect the accuracy of the data sheet: it is compulsory for users to make sure to have the latest version of this sheet.

WARRANTY

Atena S.p.A. as a manufacturer, covers the manufacturing defects of its products; Except as provided in the specific warranty extensions, the warranty period is one year from delivery of goods. Any complaints must be communicated in accordance with the sales terms and conditions.

The Atena metal celings system components have been conceived for this purpose only, any other use is considered improper.