



ATENA S.P.A. HAS A QUALITY  
MANAGEMENT SYSTEM  
CERTIFICATED BY RINA  
IN COMPLIANCE WITH ISO 9001



## Staves AC series

### ELEMENT DIMENSIONS

**AC 100** 16x85      **TA** carrier  
**AC 200** 16x185      variable distance | 15 mm gap

**AC 150** 16x135      **TD** carrier  
variable distance | 15 mm gap

Carrier maximum lenght 4000 mm.

### MATERIALS

See **Tab. 1**

### ANTISEISMIC DEVICES

Antiseismic kit for standard plenum  $\leq 1,2$  m  
Antiseismic kit for high plenum  $> 1,2$  m

### HANGERS

Duble hanger with spring | Thraded bar

### COLORS

Atena standard white and silver pre-painted steel.  
Atena standard white and silver pre-painted aluminium.  
RAL/NCS post-painting.

### FINISHING

Plain or perforated surface  
Perforation to choose among Atena perforations model.  
Wood effects | Sublimation or digital printing of any image and texture.

### PERIMETERS

"C" 18x42x25 | 30x40x40 | 16x16x20 | 18x33x25 mm  
"L" 20x25 | 20x25 | 20x20 mm  
Thickness and finishing according to project requirements

### ACCESSORIES

Staves and carrier joints.

### ATENA DIMENSIONAL TOLLERANCES

Lenght +/- 2 mm; Width +/- 0,75 mm.



**AC 100**

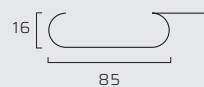

**AC 150**



**AC 200**

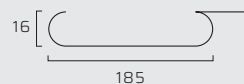









(Tab. 1)







| STAVES | GAP | DIMENSIONS   | ALUMINUM THICKNESS | STEEL THICKNESS | CARRIER  |            | INCIDENCE ML/MQ |            |
|--------|-----|--------------|--------------------|-----------------|----------|------------|-----------------|------------|
|        |     |              |                    |                 | TYPOLOGY | MATERIAL   | STAVE           | CARRIER T* |
| AC 100 | 15  | L 85 - H 16  | 5/10   6/10        | 5/10            | TA       | STEEL 6/10 | 10              | 1          |
| AC 150 | 15  | L 135 - H 16 | 5/10   6/10        | 5/10            | TD       | STEEL 6/10 | 6,7             | 1          |
| AC 200 | 15  | L 185 - H 16 | 6/10               | 5/10            | TA       | STEEL 6/10 | 5               | 1          |

T\* = According project requirements incidence of carriers and suspensions can vary. Please check it with Atena S.p.a. technical department.

## TECHNICAL PERFORMANCES

|   |   |   |
|---|---|---|
|    | <b>FLEXION RESISTANCE</b>                 | Maximum span mm 1200 - <b>1 Class</b><br>EN13964  |
|    | <b>CORROSION RESISTANCE</b>               | Galvanized steel products: <b>C2 Class</b><br>Pre-painted galvanized steel products: <b>C3 Class</b><br>Post-painted galvanized steel products: <b>C4 Class</b><br>Pre/post-painted aluminium products: <b>C5 Class</b> |
|    | <b>(RH%) RELATIVE HUMIDITY RESISTANCE</b> | Galvanized steel products: <b>≤ 90%</b><br>Pre/post-painted galvanized steel products: <b>&gt; 90%</b><br>Stainless steel and aluminium products: <b>&gt; 90%</b>   |
|    | <b>FIRE REACTION</b><br>UNI EN 13501-1    | Structure, suspensions and wall angles: <b>A1 Class</b><br>Smooth or perforated stave with Plus acoustic fleece: <b>A1 Class</b><br>Perforated stave with Standard acoustic fleece: <b>A2s1d0 Class</b>                 |
|    | <b>ACOUSTICS</b>                          | Information in "Acoustic Performance"   |
|    | <b>CLEANING</b>                           | Wet cloth with warm water and neutral non-abrasive detergents.  |
|   | <b>COLOR STABILITY</b>                    | In compliance with technical tolerances standard.<br>Test according to the ΔE - CIE Lab method.<br>ISO 7724-2 (3)   |
|  | <b>DURABILITY OF PAINTED ITEMS</b>        | C Class<br>EN13964  |
|  | <b>GALVANIZED DURABILITY</b>              | B Class<br>EN13964  |

## SUSTAINABILITY

|   |   |   |   |   |  |
|---|---|---|---|---|--|
|  | <b>RELEASE OF DANGEROUS SUBSTANCES*</b> | None<br>CAM 2.4.1.3<br>EN13964                      |  | <b>FORMALDEHYDE*</b>                    | E1 Class<br>CAM 2.3.5.5  |
|  | <b>DISASSEMBLY*</b>                     | Steel   Aluminium<br>100% recyclable<br>CAM 2.4.1.1 |  | <b>MATERIAL DEMOLITION AND REMOVAL*</b> | Non hazardous waste<br>in compliance with<br>CAM 2.5.1.                      |
|  | <b>RECYCLED PRODUCT CONTENT*</b>        | CAM 2.4.1.8<br>compliance                           |  | <b>GREEN BUILDING</b>                   | Requirements: <b>LEED</b><br>(BREEAM and ITACA<br>for cross-section aspects) |

\* Data declaration as required by the ISO 14021 standard

## AXONOMETRY AND SECTIONS

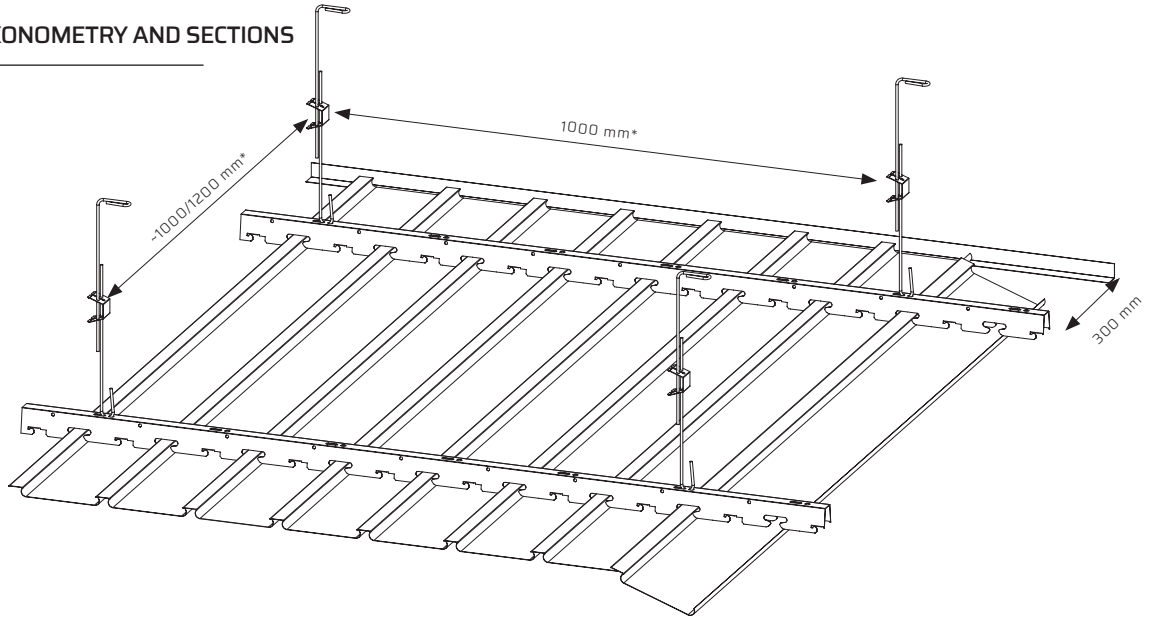

### AC 100

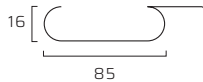

### AC 200



### AC 150

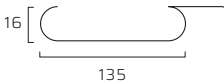

### TA CARRIER (AC 100 - AC 200)

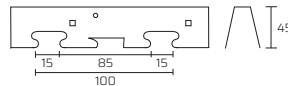

### TD CARRIER (AC 150)

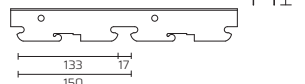

### Closed gap detail

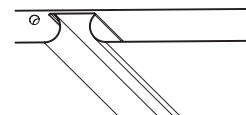

\*verify **interaxes** and **hanger models** according to the load at m<sup>2</sup> the antiseismic report and particular conditions when required. The **fastening** must be checked with regard to the loads, the anchoring base features and the installation accuracy, in order not to compromise the stability of the metal ceiling system. Lightings, accessories and systems must not weigh on the metal ceiling system, but must be independently suspended.

## COMPONENT INCIDENCES

| ID | DESCRIPTION     | INCIDENCE            |
|----|-----------------|----------------------|
| 1  | AC SERIE STAVES | *                    |
| 2  | HANGER          | 1 pcs/m <sup>2</sup> |
| 3  | CARRIER         | 1 ml/m <sup>2</sup>  |
| 4  | WALL ANGLE      | 1 pcs/m <sup>2</sup> |

## HANGERS

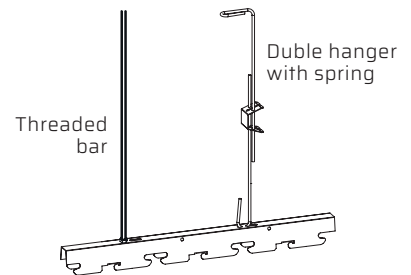

## ANTISEISMIC EQUIPEMENTS

According to the NTC 2018, when the non-structural element is assembled on site: structure designer is in charge of identifying the request, the supplier and / or installer is in charge of providing elements and connection systems of adequate capacity, the project manager is in charge of verifying the accuracy of installation". Therefore it is necessary to communicate to Atena the stresses acting on the false ceiling (seismic acceleration, wind load,..) in order to allow a proper calculation of the single elements. For more information on Atena's anti-seismic systems, contact the reference sales offices. The documentation on the site is for example only. (NTC 2018 § 7.2.3-7.2.4).

## WALL ANGLES

### "C" PROFILE

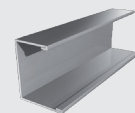

18x42x25 L=4000 mm  
 30x40x40 L=3000 mm

### "C" PROFILE

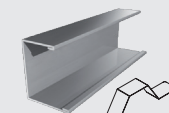

18x33x25 L=4000 mm  
 with H30 Omega spring

### "L" PROFILE

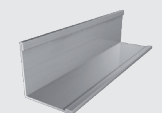

25x25 | 20x25 | 20x20  
 L=3050 mm

## INSTALLATION STEPS

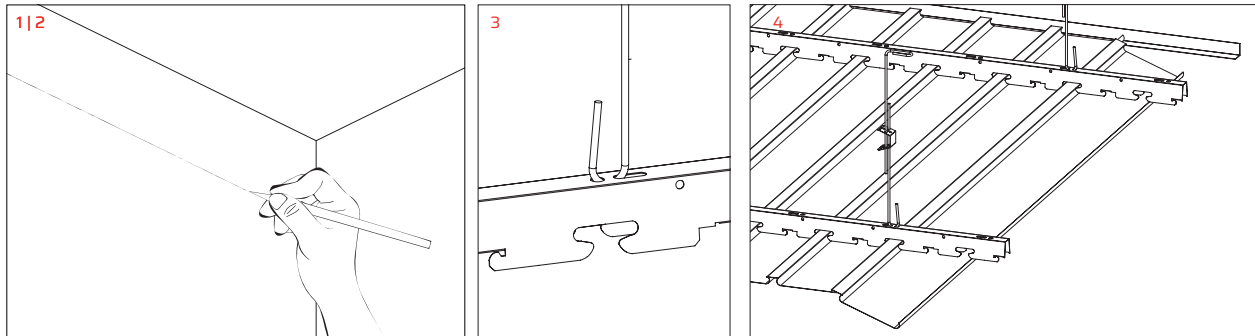

- 1 Determine the height of the metal ceiling with a level and mark it with the cord.
- 2 Install the wall angle profiles with screws and / or plugs suitable for the wall material.
- 3 Fix the hangers to the floor and hook the carriers to the special hangers, according to the distance calculated in the project. To ensure the correct alignment of the carriers, fix the appropriate joints.
- 4 Proceed with the hooking of the Staves to the carriers. To ensure the correct alignment of the staves, fix the appropriate joints.

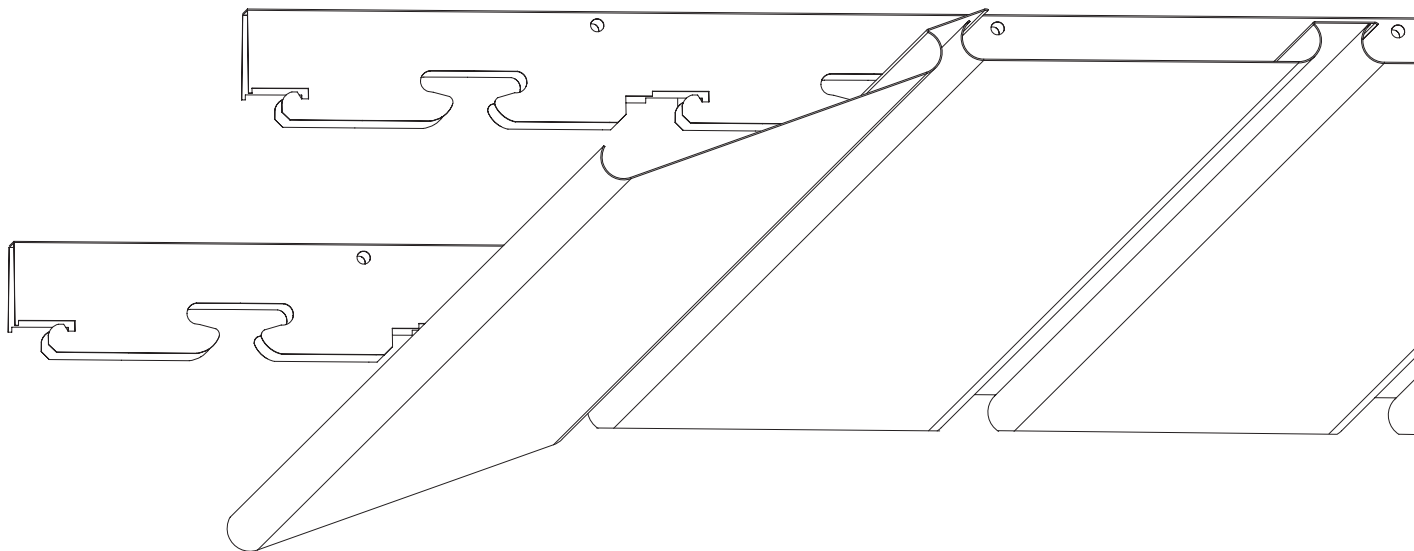

\*verify **interaxes** and **hanger models** according to the load at  $m^2$  the antiseismic report and particular conditions when required. The **fastening** must be checked with regard to the loads, the anchoring base features and the installation accuracy, in order not to compromise the stability of the metal ceiling system. Lightings, accessories and systems must not weigh on the metal ceiling system, but must be independently suspended.

To set up a proper coupling of the structure, hold the left side of the punched profile and press slightly to snap the clip into place. The click ensures the proper attachment of the structure. To release, press the tab of the locking clip and remove the profile.



## CLEANING, MAINTENANCE AND REMOVAL INSTRUCTIONS

Cleaning and maintenance require some attention and care even though are easy to make and don't take much time. It is necessary to use warm water and neutral and non-abrasive detergents. Metal ceilings maintenance usually refers to: placement, alignment or replacement of damaged or broken modules (panels, staves, baffles, open cells) which can be also removed for restoration or maintenance of the system below.

In order to ensure an excellent results, the maintenance work must be carried out by specialised workers trained with technical data sheets about setting, removal and maintenance of the metal ceilings. Using inadequate tools can damage the bearing structure, causing adherence loss or even accidental modules fall. All the maintenance intervention must follow the technical data sheet instructions or specific information when provided and every diversity has to be promptly reported. Each worker charged with maintenance operation must carefully remove the modules, perform the intervention and do not alter the metal ceiling structure, the hanging system and the connection between these elements.

When the maintenance is over, modules must be installed again, checking that these are well hooked or positioned if they are lay-in/on on a visible structure and that the flatness of the assembly is guaranteed. Any difference in level is caused by wrong installation and, for this reason, the system must be quickly controlled.

## STORAGE MODE

Materials supplied by Atena S.p.A. shall be maintained in good condition from purchase to installation. Materials must be stored in a closed, clean and dry site, not under direct light. Atena S.p.A. protects its products with resistant packaging under normal handling. Please handle packages with care to avoid shocks and inappropriate handling that might damage what is provided. The manual handling must be carried out with caution and in compliance with safety regulations at work. For carriage of packaged products on pallets, provide a mechanical transport to avoid damages or risks resulting from inadequate transport.

## SUSTANABILITY AND SAFETY

All Atena metal ceilings are made with products that do not release dangerous substances into the environment including formaldehyde. Coating and / or sublimation are free from Volatile Organic Compounds (VOC). The products will be recyclable and as a whole manufactured using recycling processes materials, the recycled material percentage is calculated for each type of product, in compliance with CAM requirements and declared according to the ISO 14021 standard. The metal ceiling systems contribute to getting credits for the certification of building design, construction and sustainable and efficient management according to the LEED protocol and to the BREEAM and ITACA cross-cutting aspects.

## FASTENERS

Atena supplies the hangers and accessories such as screws, washers and nuts to connect the elements of its own supply only. Lightings, accessories and systems must not weigh on the metal ceiling system, but must be independently suspended. The fastening must be checked with regard to the loads, the anchoring base features and the installation accuracy, in order not to compromise the stability of the metal ceiling system.

## **NORMATIVE REQUIREMENTS**

Atena S.p.A. has adopted a quality management system in compliance with the UNI EN ISO 9001 standard.

All Atena metal ceilings are produced for indoor applications, in compliance with Technical Standards for Construction NTC 2018 and relative circular requirements, the Minimum Environmental Criteria CAM (Ministerial Decree 11 October 2017), the specific technical standards applicable UNI EN 13964 and 14195. Each Atena S.p.A. product has its own DOP (CE Declaration of Performance) according to the European Law for construction products 305/2011.

The performance properties declared in D.o.P. Declarations of Performance provided by Atena S.p.A. are guarantees, if the metal ceiling is installed in the environment conditions for which it has been conceived and the recommended maintenance is executed.

Precisely, metal ceilings are non-structural construction elements therefore they must be properly sized in order to withstand with adequate safety against all actions that can stress the building, such as, but not limited to, earthquakes, winds, thermal expansion, humidity, etc., in relation to the installation site, the building use and the project technical features. Check with Atena technical department the specific environmental conditions to which the product will be subjected, in order to choose the most suitable materials for the installation site.

In the case of outdoor installation, the metal ceilings are not covered by an harmonized technical standard, therefore they are not subject to the regulation 305/2011. They are in any case subjected to the NTC 2018 and to the safety checks of civil constructions, and must be properly sized according to the installation site environmental conditions, to the structural features and to the project specifications.

Independently by information, suggestions, advices and technical opinions exchanged between the parts, during pre-agreement negotiations Atena S.p.A. will manufacture the products only according to the orders received and the technical drawings/projects attached, having no responsibility on what is not indicated in the order, in the technical drawings or in the project.

All rights are reserved and subject to industrial protection. Changes to the illustrated products, even if partial, can be carried out only if explicitly authorized by the company Atena S.p.A. All data provided and illustrated are indicative and Atena S.p.A. reserves the right to make changes at any time according the business needs and the production processes.

The information contained in this following sheet must to be considered updated at the date of writing. Changes in product performance occurred after that date may affect the accuracy of the data sheet: it is compulsory for users to make sure to have the latest version of this sheet.

## **WARRANTY**

Atena S.p.A. as a manufacturer, covers the manufacturing defects of its products; Except as provided in the specific warranty extensions, the warranty period is one year from delivery of goods. Any complaints must be communicated in accordance with the sales terms and conditions.

The Atena metal ceilings system components have been conceived for this purpose only, any other use is considered improper.